



**NONWOVEN**

**STAY ON TOP OF  
ADULT CARE BUSINESS**

**FOR YEARS TO COME**

**ANDRITZ**

**ENGINEERED SUCCESS**



# CONTENTS

Company profile	4
Build your future in hygiene converting	6
Dedicated service	8
Full range in nonwovens production	10
Develop your hygiene products with our experts	11
Innovative solutions for hygiene products	12
Foresee digitally with Metris	14
Adult pants converting machines	16
Adult diaper converting machines	20
Light inco converting machines	24
Underpad converting machines	28



## TECHNOLOGY SOLUTION PROVIDER

As the market becomes more and more demanding, ANDRITZ Diatec offers the latest technology solutions with a wide range of customization options to help customers find the right machine configuration to save time and money.



## FULL MACHINE PORTFOLIO RANGE

ANDRITZ Diatec is able to supply turnkey converting machines for the production of a comprehensive range of sanitary products:

- Baby diapers
- Baby pants
- Adult diapers
- Adult pants
- Underpads
- Light Inco products
- Shaped pads
- Sanitary napkins
- Panty shields
- Food pads
- Lamination



# A reliable partner



**ANDRITZ Diatec** designs and manufactures a wide range of machines and technology solutions for the production of baby diapers, baby pants, adult incontinence products, sanitary napkins, panty shields and underpads. Always at the forefront of innovation, ANDRITZ Diatec has broadened its production horizons by delivering new lines for food pads, lamination, medical products, disposable gloves, headrests, surgical drapes and spool winding equipment. ANDRITZ Diatec is now part of the ANDRITZ Nonwoven business.

## KEY TO SUCCESS

The key factor in our success is the relationship that we create and maintain with our customers from the design of the machine to the “nurturing” phase during machine installation intended to offer specialized support for a smooth start-up in the customer’s plant.

## DISTINCTIVE TRAIT

Important added-value from ANDRITZ Diatec is the capability to respond quickly and promptly to the changing needs of the present-day market, allowing customers to seize opportunities and translate them into concrete projects. We also provide full project management, from planning control to start-up of the line in order to secure a prompt return of investment.

## YOUR BENEFITS

- Customer care
- Customer satisfaction
- Spare parts
- After-sales assistance
- ANDRITZ guarantee

# Build your future in hygiene converting

In order to cover all of your final product and production requirements, our machine portfolio ranges from market entry to high capacities, precisely designed to meet your needs. The machines are built with a modular frame that allows customized configuration. Moreover, the compact layout ensures a smooth start-up and easy machine maintenance. Machines and retrofits can be installed easily according to customers' requirements. The full servo-technology simplifies ordinary operations and adaptation of the raw materials to the environmental conditions.

## BENEFIT FROM A TRUSTWORTHY PARTNER

ANDRITZ Diatec machines are characterized by the use of high-precision mechanical tooling and high levels of automation. The bulky structure of the core formation provides stability and ensures minimized vibrations, thus making the production environment more pleasant. The production process is easy to monitor and adjust during operations. Our machines achieve high efficiency in terms of OEE and low waste rates. The use of top-notch components ensures long-term reliability of the machines and consistent savings in terms of spare parts and technical intervention.

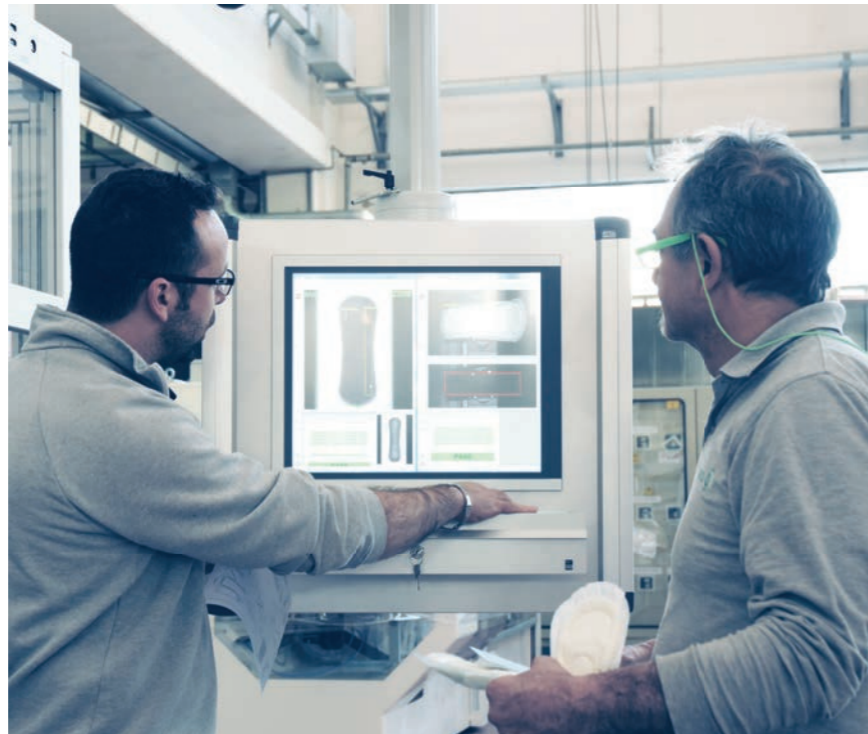

## CONSTRUCTION PHILOSOPHY

All our machines are designed, manufactured and tested entirely in Italy, using EU or US components, in compliance with CE regulations. Depending on customers' needs, ANDRITZ Diatec offers customized solutions according to production volumes, product recipes and all requirements relating to the customer's production plant. We

also ensure that we respect the project timing in order to meet customer's requirements. We are able to offer a full-range of extensions and retrofitting kits to keep our customers' machines state-of-the-art.

## MACHINE MANAGEMENT

Our machines are easy to manage. All machine parameters can be

easily set, stored in the memory, recalled and changed according to the needs of the customer. All operations are carried out with the highest efficiency and security levels in order to simplify daily operations on the machine. A fast and easy size change configuration reduces machine downtime and hence increases production output.

## YOUR BENEFITS

- Easy machine management
- Fast size change
- Limited number of operators required
- Linear production process
- Optimized raw material consumption
- Reduced energy consumption

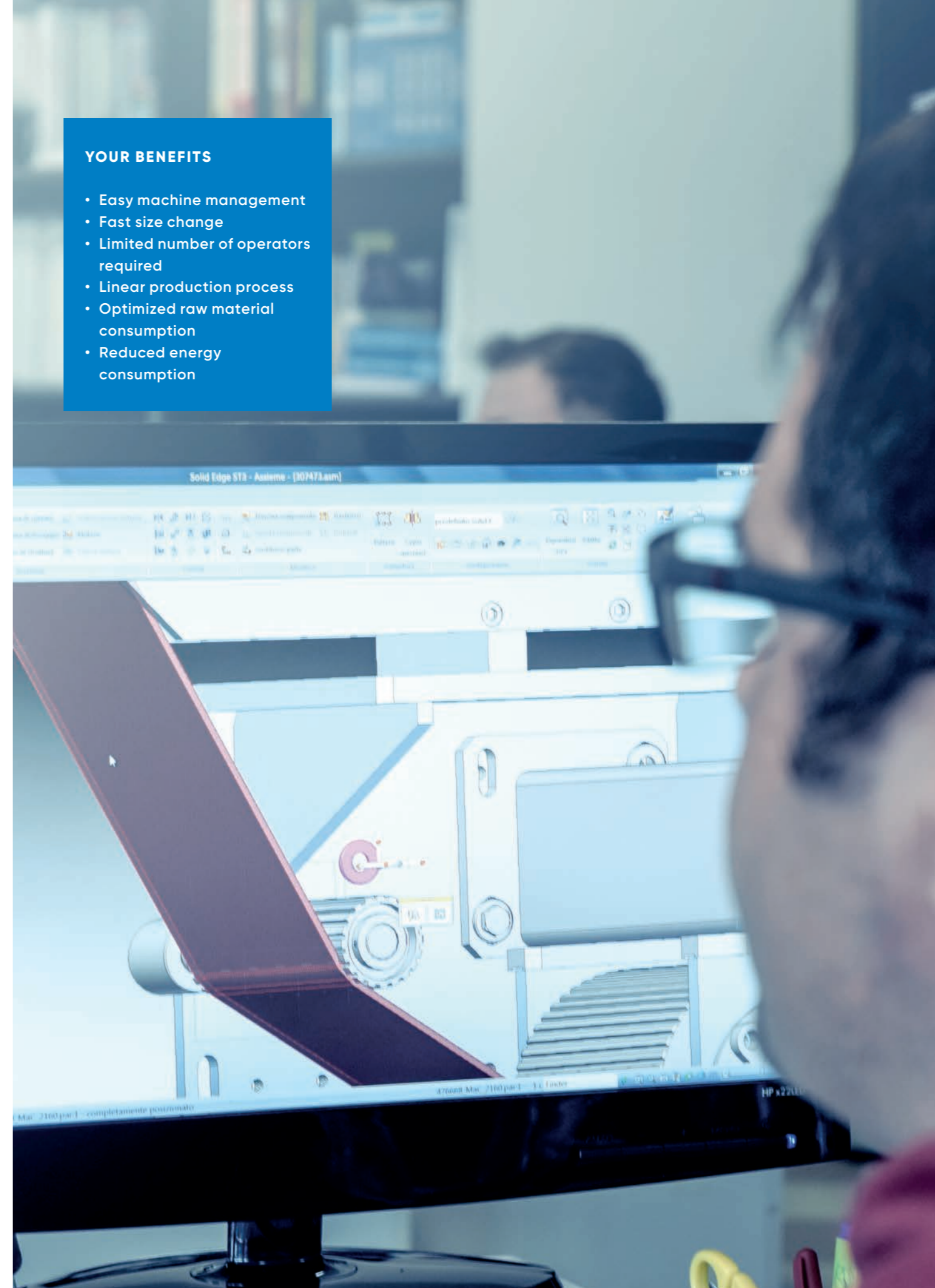

# Dedicated service

## We know how important uptime is for your production efficiency:

We do everything to keep interruptions to a minimum. With remote assistance and a highly responsive service team, we can react to your issues in the shortest time possible.

### FAST MACHINE START-UP

Our machines are thoroughly checked before shipment so as to speed up the start-up in the customer's plant and reduce machine downtime.

### SPARE PARTS

We guarantee the supply of original spare parts with onsite installation, in accordance with the customer's timing and efficiency demands.

### MAINTENANCE

Machine maintenance is made easier by the compact machine

layout, which leaves wide spaces for movement around the machine. Every process is linear and complies with the highest safety levels. Cost and time savings, efficiency and durability are guaranteed by the high quality of engineering and components used.

### REMOTE ASSISTANCE

ANDRITZ Diatec is there for you at all times. Remote assistance is critical to guarantee that machine performance is kept high. Our engineers are always at your disposal by helping you identify problems and find remedies

promptly. In this way, operators' maintenance skills are improved and after-sales costs for interventions and machine stoppages are reduced.

### AFTER-SALES SERVICE

ANDRITZ Diatec shares trust and growth with customers. This value is mirrored in the wide range of services that we offer.



### YOUR BENEFITS

- Spare parts installation
- Safety inspections
- Preventive inspections for routine maintenance
- Production supervision
- Technical documentation



### UPGRADES AND RETROFITS

Our machines have a long lifecycle. The modular and compact frame makes refurbishment operations easier. Throughput can be optimized significantly by means of tailored upgrades, which also enable the final product structure to be updated in line with market demands.

### SERVICE SUPPORT

- Control equipment and software upgrades
- Analysis of existing machines to upgrade and optimize production
- Training programs for machine operators

# Full range in nonwovens production

**Let our experience drive your innovation:** A remarkable impact on nonwovens technologies: Whether hygiene or medical, automotive or building, household or technical – nonwovens applications are manifold. Their outstanding properties require excellent engineering in an increasingly changing and growing market. You can rely on a competent partner: with a passion for nonwovens technologies and with spot-on solutions perfectly suited to your specific needs.

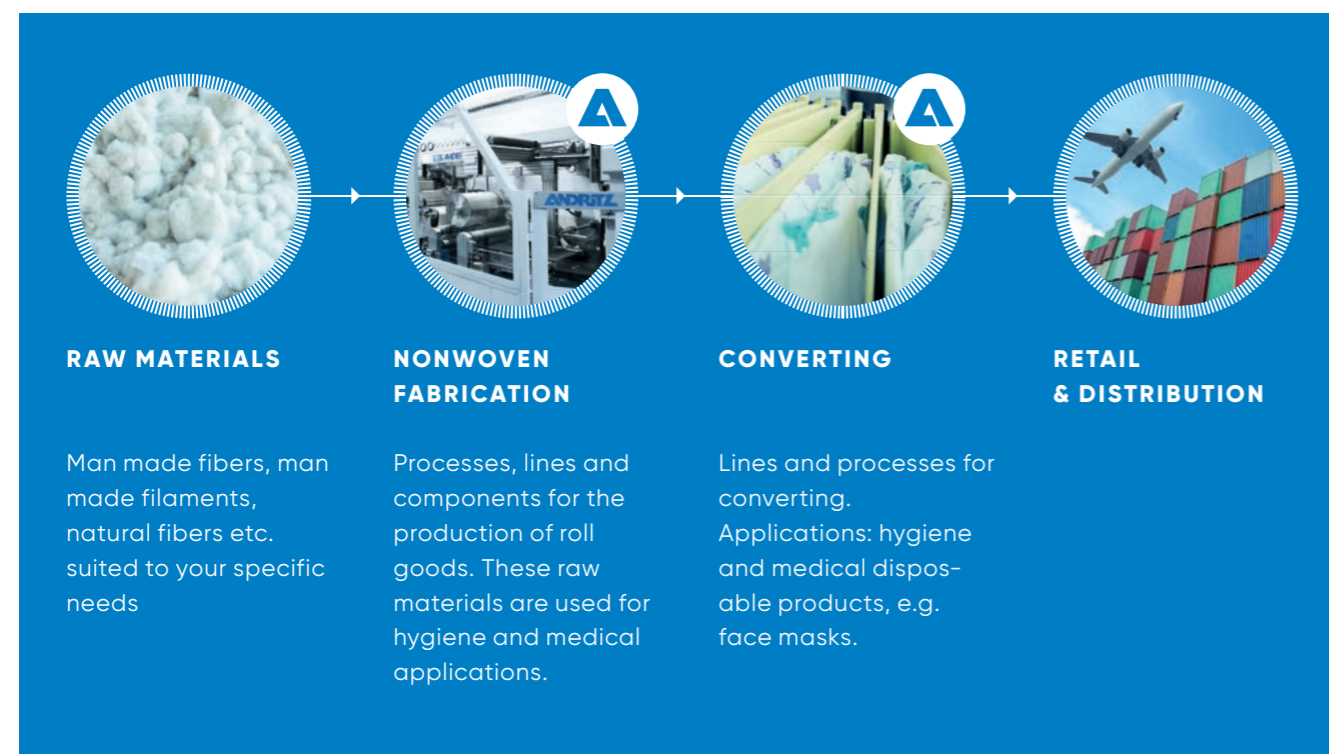

## NONWOVENS UNLIMITED

ANDRITZ is a machinery supplier to offer nonwoven processes for roll goods production and also converting lines. In this way, ANDRITZ covers a great part of nonwovens value chain. Its expertise in the treatment of raw materials and market know-how of

possible end uses bring unique added-value for the nonwovens industry. Hygiene is a part of the DNA at ANDRITZ and thanks to the spunbond, spunjet, air-through bonding and spunlace pilot lines, all materials used in the converting lines can be tested and approved by the market in advance.

# Develop your hygiene products with our experts

**Continuous research and development targeting your needs:** In an ever more demanding market, get the most out of your investment with the support of our test equipment and highly skilled engineers. You can benefit from more than three decades of experience and expertise.

## RESEARCH AND DEVELOPMENT

Being dedicated to high quality and innovative production technologies propels us to seek ideal solutions. Let our combined forces achieve maximum results.

Highly skilled staff provide unique know-how drawn from our installed base and continuous R&D.

## SPUNLACE TECHNICAL CENTER

Our spunlace pilot line in Montbonnot, France, includes state-of-the-art equipment to produce a wide range of spunlace fabrics. During the trials, the pilot line is able to operate at up to 500 m/min. Tests can be conducted in-line with the TT card or off-line with an unwinder. It is also equipped with a complete water filtration system so that trials can be conducted with all types of fibers. You can test natural or synthetic fibers, short or long fibers, paper fibers, and so on.

## SPUNLAID TECHNICAL CENTER

Our spunlaid technical center in Krefeld, Germany, includes a wide range of pilot calenders for different applications and needs, more than 200 engraved rolls and shells, various sleeves, measurement systems and a 3D-microscope. It is well-equipped to handle many

fields of application like embossing for wipes, calibration for melt-blown material, laminating of roofing material or filters, thermo-bonding, perforating of top-sheets, compacting of wetlaid fabrics, comparisons between thermal and ultrasonic laminating, or textile finishing.

## WETLAID TECHNICAL CENTER

Our wetlaid pilot line in Krefeld, Germany includes state-of-the-art equipment to produce a wide range of wetlaid fabrics for the automotive, aerospace, agriculture, construction, medical, wipes and hygiene industries, as well as the household goods sector. Arrangement of the components on a rail system ensure highest flexibility when extensions or modifications are needed.

## AIR-THROUGH-BONDING TECHNICAL CENTER

CETI, the European Center for Innovative Textiles, is a research center for new textile applications and is located in Lille, France. ANDRITZ has been supplying the institute with the latest nonwoven technologies, including air-through bonding. The air-through bonding pilot line provides CETI and its customers with a R&D platform

for both flat and Omega ovens for prototyping the fast growing trends in hygiene applications.

## YOUR BENEFITS

- Process expert support
- Equipment containing the latest technology
- Integrated laboratory to test nonwoven fabrics
- Simulation tool



# Innovative solutions for hygiene products

**ANDRITZ offers you customized solutions:** For the production of hygiene products, we can deliver tailor-made processes. Take advantage of the vast expertise that ANDRITZ has to offer in a wide range of hygiene nonwovens technologies, such as web forming and finishing (air-through bonding, spunlace, spunlaid, spunjet, wetlace) and converting (baby diapers, feminine hygiene, adult incontinence).

## COMPLETE AIR-THROUGH BONDING (ATB) LINES

The ANDRITZ air-through bonding lines deliver all nonwovens fabric characteristics for hygiene end uses, such as top-sheets and acquisition distribution layers, and back sheets. The well-known ANDRITZ carding machines are the key to success in achieving perfect web uniformity and comfort. With the ANDRITZ air-through bonding line, you can benefit from high production capacity and high-performance fabrics from 16 to 80 gsm made from bi-component fibers produced at high speeds of up to 250 m/min.

## COMPLETE SPUNLACE LINES

ANDRITZ is an active player in most of the world's spunlace production. In order to meet the market demands, ANDRITZ offers you a wide range of complete spunlace lines combining performance, efficiency and profitability. The premium line layout combines very high capacity of up to 25,000 t/a with low energy consumption and is able to produce all types of spunlace roll goods. Spunlace fabrics are made from all types of raw materials – natural or synthetic. Softness, drape, comfort, comfortability, high strength, and the fact that they contain no chemicals are the major characteristics that make spunlace nonwovens unique.

## YOUR BENEFITS

- ANDRITZ expertise in hygiene market
- Perfect web uniformity
- Versatility of fibers
- Technical centers: spunlace in Montbonnot, France; spunbond/calendering/wetlaid in Krefeld, Germany and air-through bonding at CETI, France
- Expertise in testing and converting

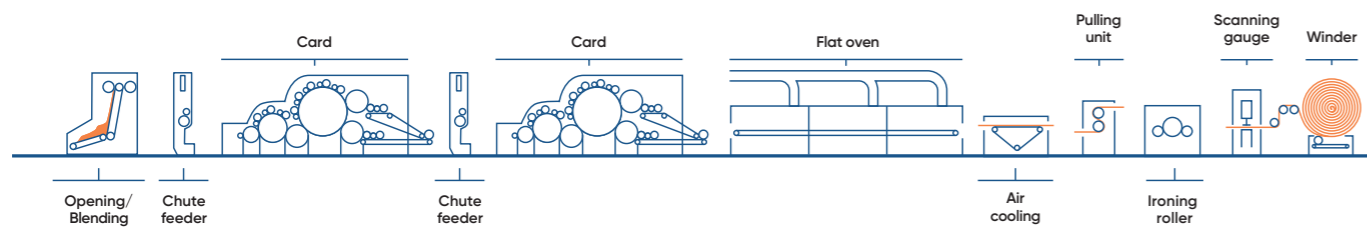

ANDRITZ air-through bonding line for hygiene end-uses, 16-80 gsm

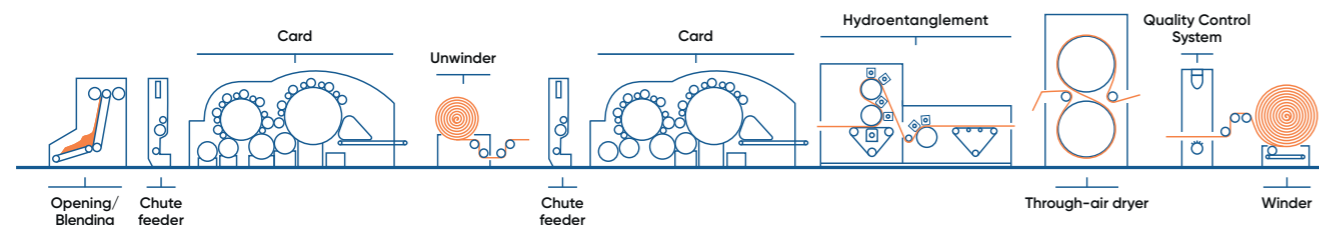

ANDRITZ spunlace line for medical and wipes end-uses, 30-100 gsm

## COMPLETE SPUNBOND FINISHING LINES

ANDRITZ spunbond solutions: You benefit from the highest capability, reproducibility, reliability, and efficiency. Find the best solution, perfectly suited to your needs, for thermobonding and finishing processes like embossing, compacting, lamination, or perforation. Besides calendering technologies, you'll find solutions for your complete finishing process with neXline finish. This encompasses calender, spunjet technology, finishing solutions, and dryer – turnkey solutions from just one source.

## PRECISELY WHAT YOU NEED

If you need a complete system solution, a single unit, a rebuild, an automation system, or comprehensive life-cycle services: We can meet your demands and deliver precise technologies, from bonding to finishing, for your product.

## THE EXPERTS IN CALENDERING

Let your products benefit from over 60 years of experience and comprehensive project management. With more than 600 nonwovens calenders in operation worldwide and installations in all high-end nonwovens lines, you are ensured top performance from ANDRITZ.

Benefit from reliable, flexible and proven technologies based on more than 750 innovations with worldwide patents along with innovative processes and engineering depth.

Depending on your final product and its parameters, such as strength, softness, or air permeability, our nonwoven calender portfolio ranges from low and medium capacities (aXcess range) to high capacities (eXcelle range), precisely designed to meet your needs.

## SPUNJET – A BONDING SOLUTION FOR ENDLESS FILAMENTS

The patented nonwovens process called Spunjet is the in-line hydroentanglement of continuous filaments, creating a new generation of spunlaid nonwovens. Spunjet offers you the best properties ever achieved in 80% of existing and in new nonwovens applications.

By combining two first-class bonding technologies, you can benefit from the typical strength of spunlaid as well as the softness of spunlace. The spunjet process offers you additional softness, bulkiness, drape, and tensile strength while maintaining the isotropic MD / CD ratios in your fabric properties.

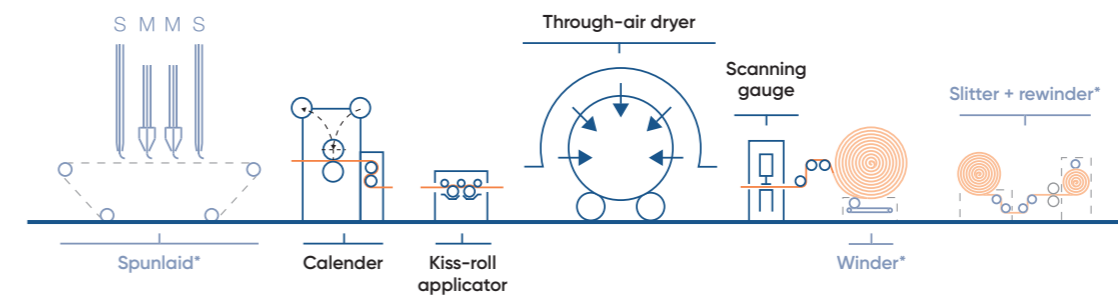

ANDRITZ spunlaid finishing line for hygiene and medical end-uses, 8-80 gsm

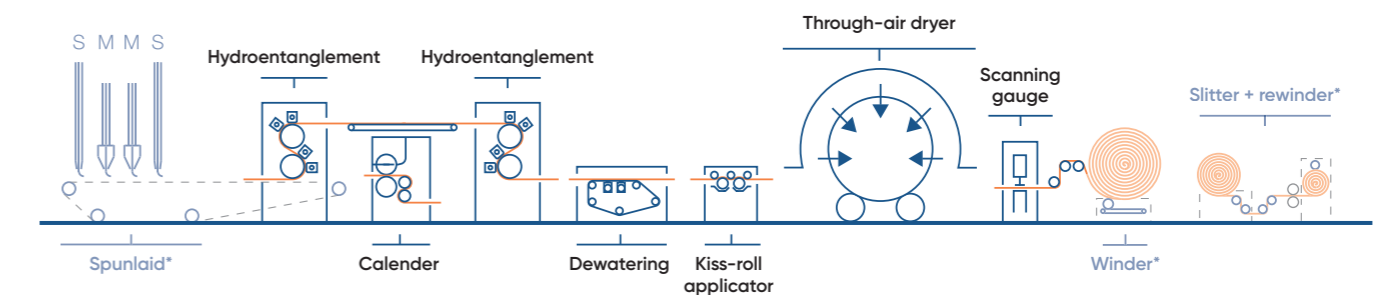

ANDRITZ spunjet line for the production of new generation spunlaid nonwovens, 20-80 gsm

\* Technology provided by cooperation partners

# Foresee digitally with Metris

Industrial Internet of Things (IoT) Industry 4.0, digitalization – current buzzwords that industries use when seeking to improve their performance and equip themselves for the future of industry.



## ANDRITZ DIGITAL SOLUTIONS

As a technology leader with extensive and long-term experience in supplying industrial measurement, control, and optimization solutions for various industries, ANDRITZ is combining process and equipment expertise with the latest enhancements in the digital era. The result of this powerful combination is Metris: a portfolio of ANDRITZ Digital Solutions.

## METRIS OPP

One of the flagship capabilities of the Metris assortment is its ability to optimize industrial processes with Metris OPP. It has been developed over the past decade within the pulp and paper sector and has recently been introduced to the nonwovens industry. It combines powerful analytical and data mining software with the knowledge of the world's top process experts to deliver a smart service initiative for customers.



## A CONSTANTLY GROWING PORTFOLIO

The depth and effectiveness of the Metris portfolio continues to improve thanks to ongoing R&D, collaboration with key customers and institutions, and venture activities. Portfolio options all rely on the three strategic focus areas of the Metris brand: Industrial IoT



technologies, Smart Service concepts, and Venture activities. The main technological advancements integrated into individual Metris products are derived from big data analytics, smart sensor technologies, and augmented reality solutions. The Metris UX platform providing full support throughout the entire lifecycle of a



plant is the most recent of our IoT developments. With Metris solutions, customers foresee digitally due to the continuously improved portfolio and its performance – and to ANDRITZ providing tailored and fully integrated digital solutions from a single source.

## Benefits

### Metris - ANDRITZ Digital Solutions

- IIoT solutions across business segments
- Combined know-how from ten years' experience with Metris OPP
- Using the latest smart sensor technologies
- Big data analysis with tried-and-tested models for deviation analysis
- Providing information locally with augmented reality
- Extensive solution and process engineering knowledge
- Cyber security solution to safeguard data on the network



# Adult pants converting machines

**Set new standards for adult pants:** ANDRITZ Diatec D-TECH adult pants platforms feature a state-of-the-art process with highest quality standards. All machines are customizable and offer top-class components and advanced technology solutions for the benefit of customers. To respond to the challenges of adult pants machines, ANDRITZ Diatec has developed ultrasonic side seam technology, which ensures bond strength and system reliability without interfering with machine speed.



D-TECH adult pants

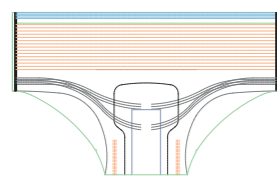

Adult pants

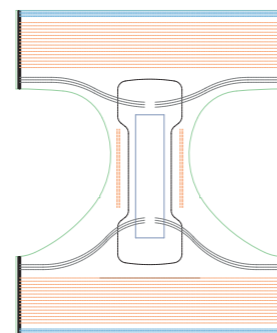

## PRODUCT FEATURES

- Different sizes from discreet to XXL and customizable shapes
- Top quality cores with optimum pad integrity
- Elastic waistband:
  - Elastic yarns
  - Inline breathable laminate
  - Pre-laminate
- Cloth-like or breathable PE backsheet
- Wetness indicator
- Disposable tape
- Protective underwear product

Single yarn control unwinding system



## PRODUCT COMPOSITION

1. NW textile backsheet
2. PE backsheet
3. Leg elastic
4. Core
5. Acquisition layer
6. NW topsheet
7. Cuff elastic
8. NW leg cuff
9. Tape disposal
10. External NW waistband
11. Waistband elastic
12. Internal NW waistband
13. NW insert overlap

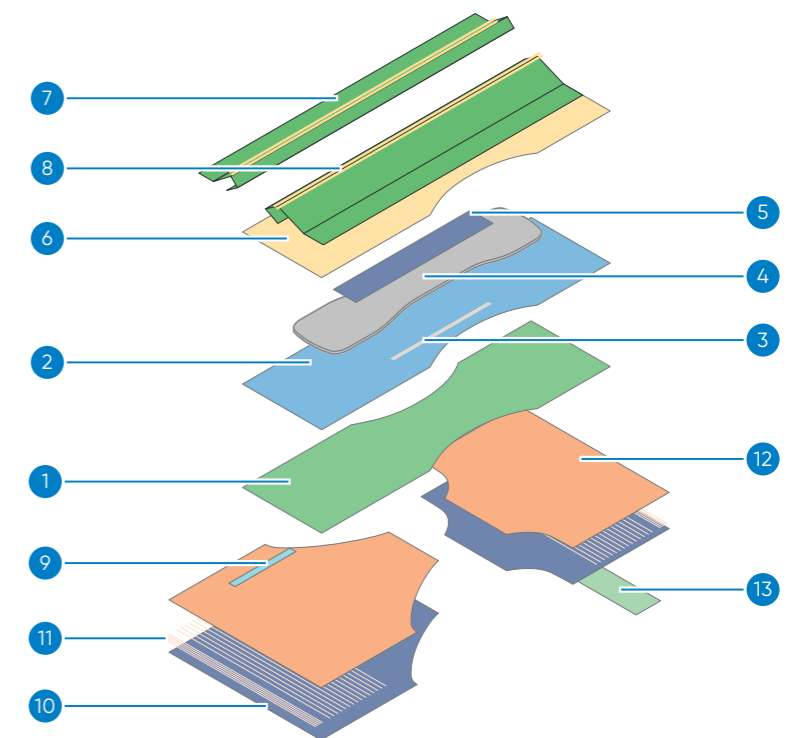

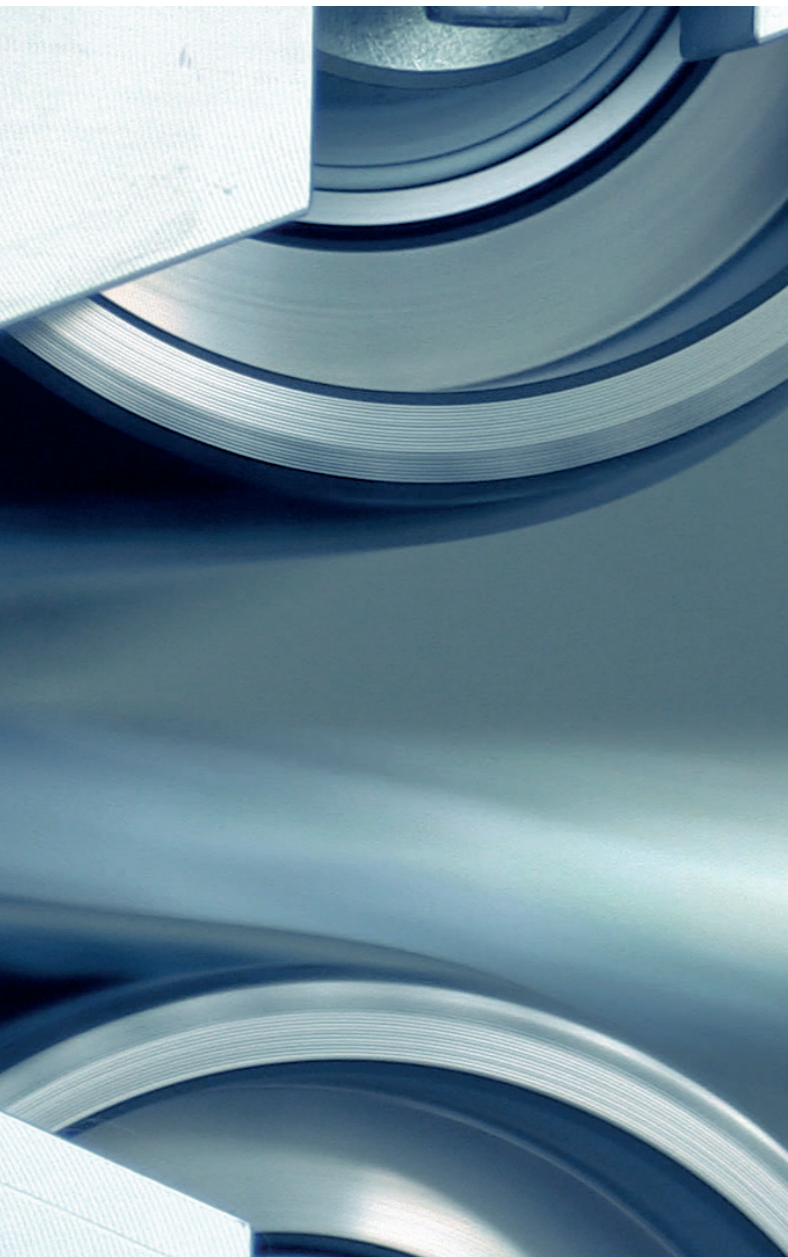

Final press conveyor

### MACHINE SPECIFICATIONS

Linear speed	Up to 250 m/min
Production speed	Up to 300 pcs/min
Uptime efficiency	85%
Waste	1-3%
Product dimensions	W: up to 1,000 mm
Electric power supply	220/480 Vac, 50/60 Hz 3 phases + N + PE (24 Vdc auxiliary)
Consumed/installed electric power	350-600 kW
Compressed air supply/consumption	6 bar/3,000 NI/min
Overall dimensions (LxWxH)	37,000 x 12,000 x 6,000 mm
Total weight	130-145 tons
Required crew	2 persons (1 operator + 1 auxiliary)
Safety standard	CE

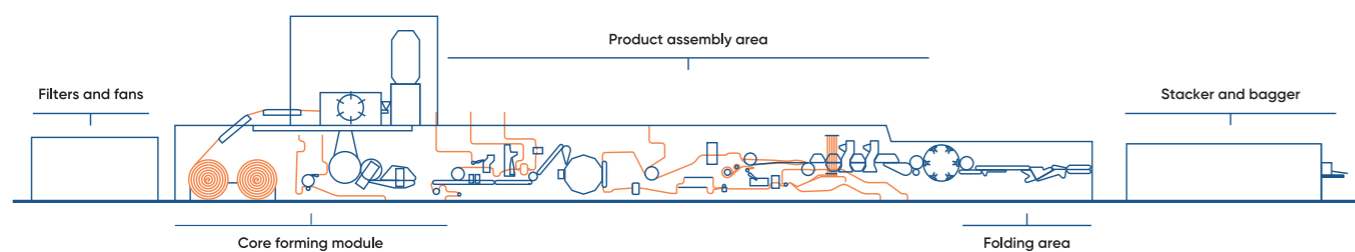

90° turning unit

### YOUR BENEFITS

- Modern forming system for higher S.A.P. concentration
- Integrated insert cutting, turning and placing system for maximum process stability
- Innovative ultrasonic side sealing solutions for higher strength and system reliability
- Ergonomic and operator-friendly process
- Fast and easy operation and size change
- Customized process and machine layout for specific needs

In adult pants machines, components can be easily combined and configured for the specific product required.

### CORE FORMING MODULE

- Cellulose pulp stand
- Compact disc mill (or hammer mill) with double inlet
- Drum former, 3D or flat
- Core processor
- S.A.P. dosing system

### PRODUCT ASSEMBLY AND FINAL CUTTING AREA

- Backsheet processing units
- Leg cuff creating system (glue, thermo, ultrasonic)
- AQL cutting and splitting unit
- Waistband elastic lamination system (glue, ultrasonic)
- Curved elastic application system
- Elastic cutter
- Integrated insert module
- Disposable tape applicator
- Offline unwinders with automatic splicers

### FOLDING AND FINAL CUTTING AREA

- Rotary die unit
- Longitudinal folding system
- End sealing system (ultrasonic)
- End cutting station
- Final turn and repitching drum
- Final longitudinal folding system
- Bi-folding system
- Reject system

- Full servo-motion system
- Hot-melt system
- Manuals, drawings and software

### OPTIONAL EQUIPMENT

- Second drum former
- Online backsheet lamination
- Additional size change kits
- Quality system LS with line scan camera
- Wetness indicator application
- Metal detector
- Lotion application system
- Glue vision system

# Adult diaper converting machines

**Customize your choice with the right adult diaper platform:** The converting process for adult incontinence products requires premium quality standards, high capacities and top-level production efficiency by reducing labor costs and machine down time. ANDRITZ Diatec D-TECH adult diaper machines can produce the complete range of diapers from classic leg-shaped to side-panel products. Zero-waste cut solutions for both symmetrical and asymmetrical side panels are available to save expensive raw material and thus reduce the cost of the final product.



D-TECH adult diaper

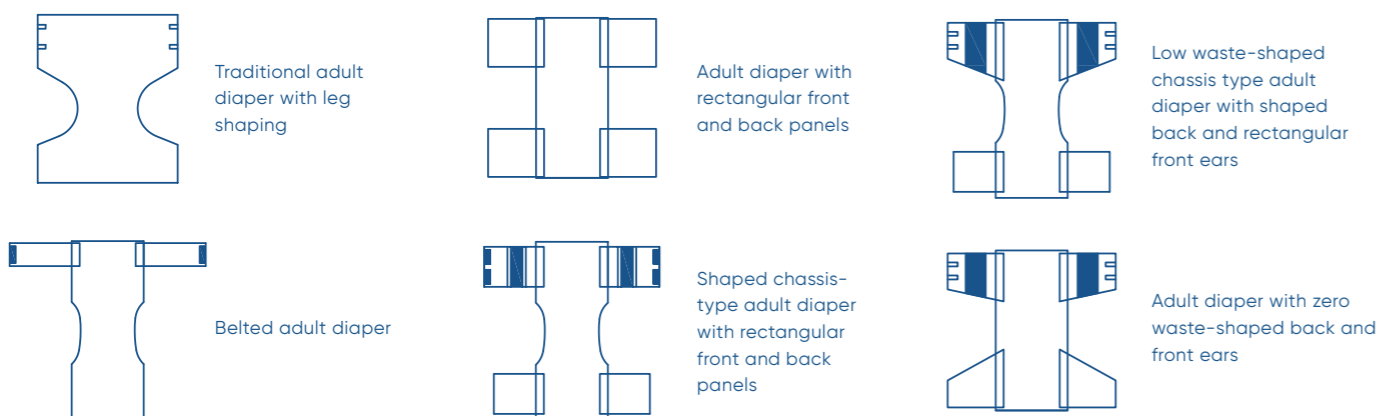

## PRODUCT COMPOSITION

1. NW backsheet
2. PE backsheet
3. Leg elastic
4. Bottom core
5. Top core
6. Acquisition layer
7. NW topsheet
8. Leg gathers
9. Leg elastic
10. Front side panel
11. Back side panel
12. Hook fastener
13. Elastic material

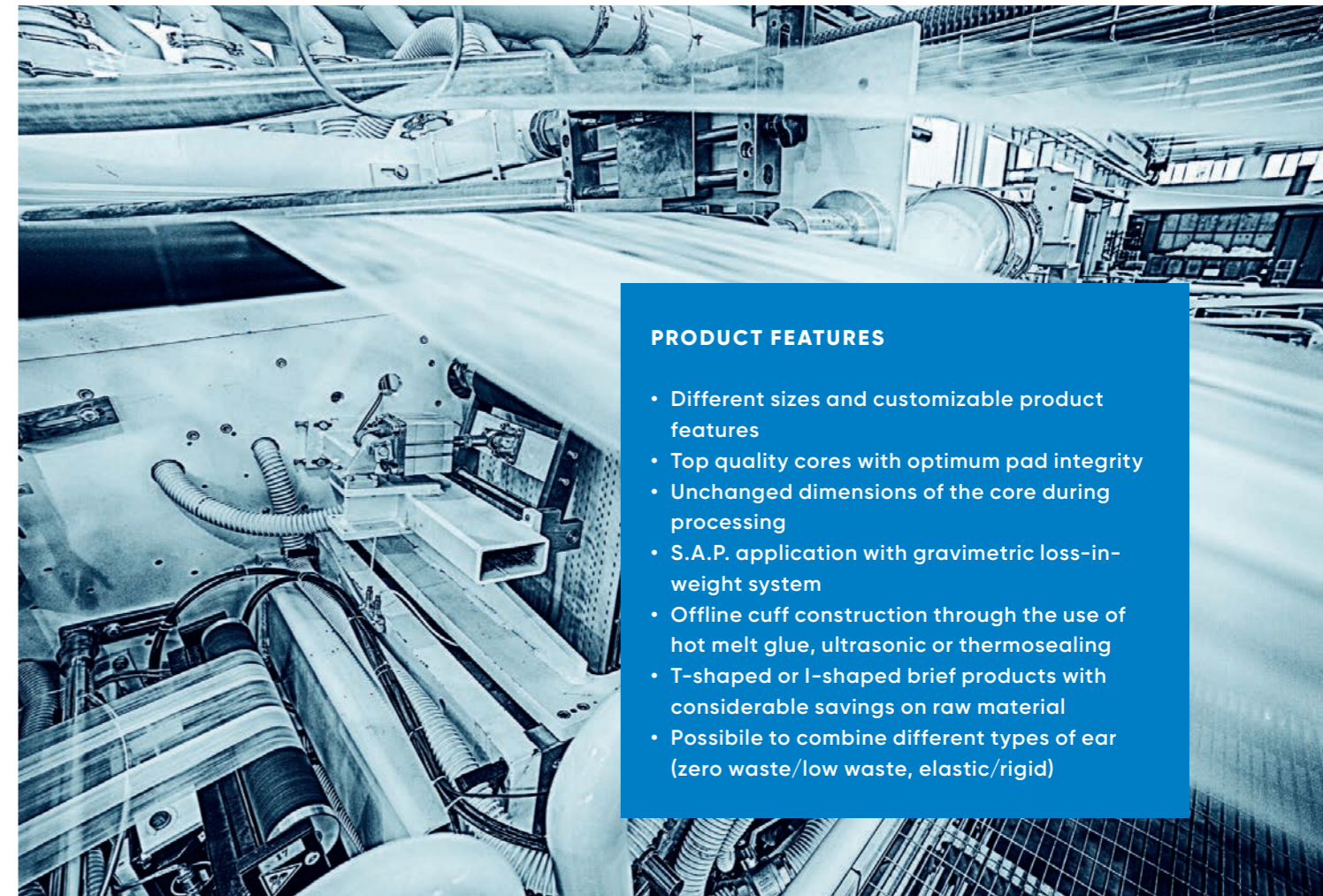
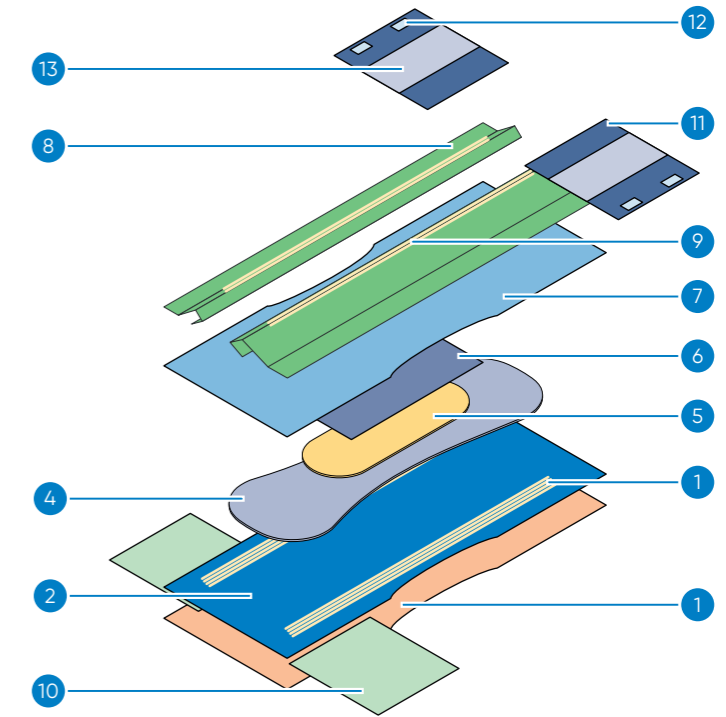

Web entry in-line

## PRODUCT FEATURES

- Different sizes and customizable product features
- Top quality cores with optimum pad integrity
- Unchanged dimensions of the core during processing
- S.A.P. application with gravimetric loss-in-weight system
- Offline cuff construction through the use of hot melt glue, ultrasonic or thermostealing
- T-shaped or I-shaped brief products with considerable savings on raw material
- Possible to combine different types of ear (zero waste/low waste, elastic/rigid)

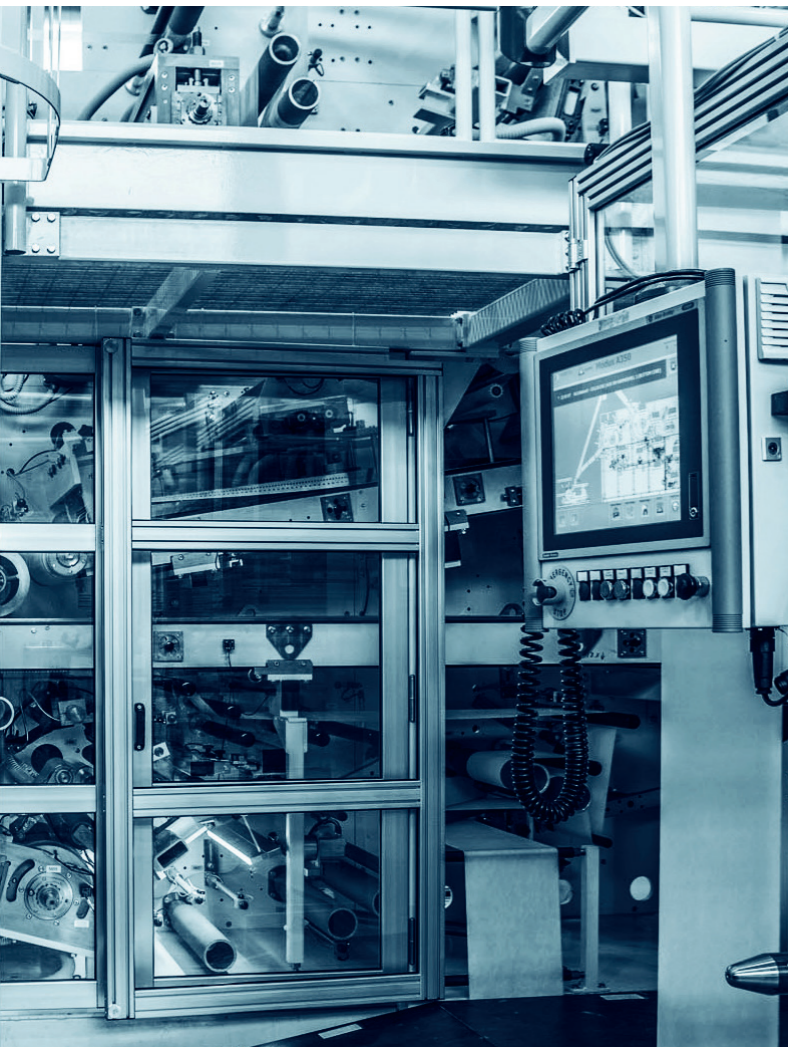

Easy maintenance mezzanine

### MACHINE SPECIFICATIONS

Linear speed	Up to 450 m/min
Production speed	Up to 450 pcs/min
Uptime efficiency	85%
Waste	1-3%
Product dimensions	W: 400-850 mm L: 400-1,050 mm
Electric power supply	220/480 Vac, 50/60 Hz 3 phases + N + PE (24 Vdc auxiliary)
Consumed/installed electric power	330-600 kW
Compressed air supply/consumption	6 bar/3,000 NI/min
Overall dimensions (LxWxH)	23,500 x 12,500 x 5,300 mm
Total weight	130-145 tons
Required crew	2 persons (1 operator + 1 auxiliary)
Safety standard	CE

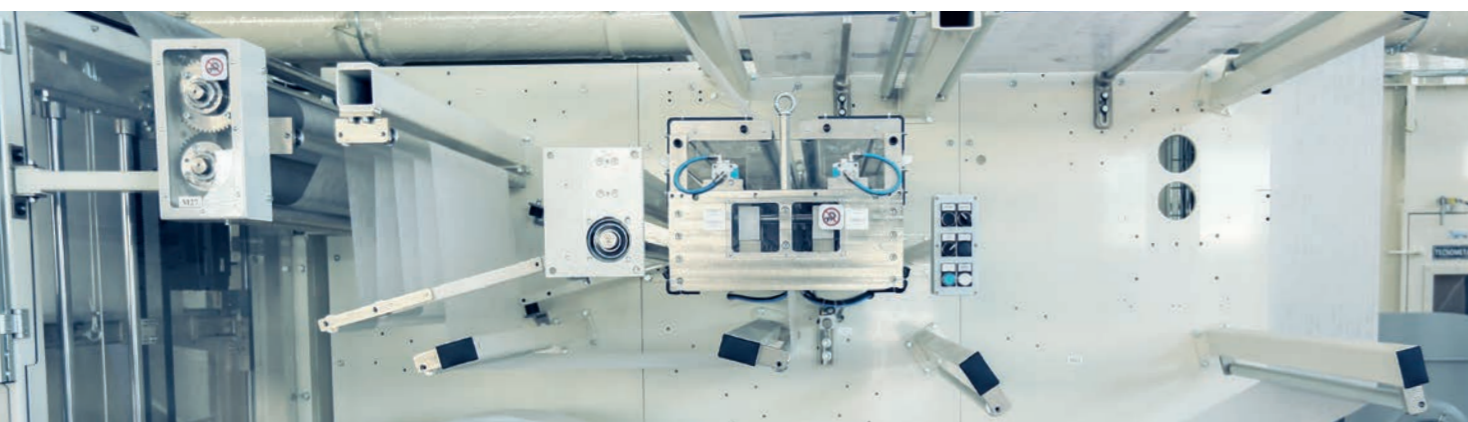
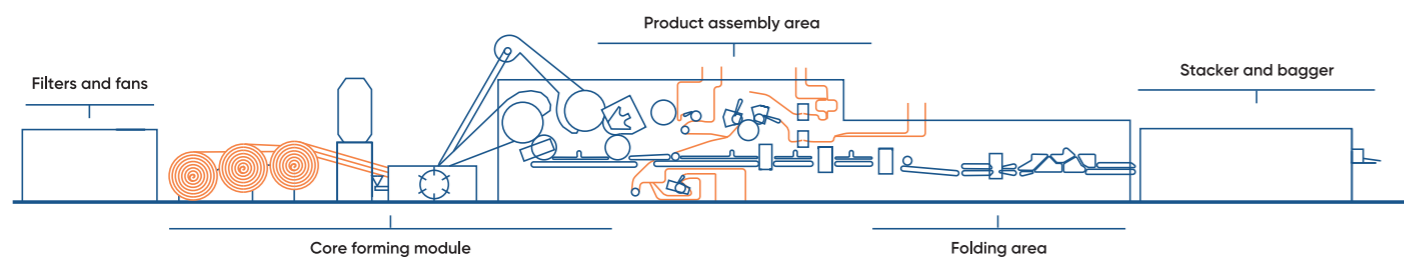

Automatic splice



### YOUR BENEFITS

- Fully customized configuration
- From concept and engineering to start-up and service, our experts are close to you
- Operator-friendly handling of machinery and process
- Fast size change
- Flexibility in core composition and S.A.P. concentration

D-TECH adult diaper

In adult diaper machines, components can be easily combined and configured for the specific product required.

#### CORE FORMING MODULE

- Cellulose pulp stand
- Compact disc mill (or hammer mill) with double inlet
- Drum former, 3D or flat
- Core processor
- Take-away drum
- S.A.P. dosing system

#### PRODUCT ASSEMBLY AREA

- Backsheet unwinder
- Leg elastic unwinder
- Acquisition layer unwinder with cut and slip unit
- Elastic waistband unwinder with disc applicator
- Topsheet (non woven and leg cuffs) unwinder
- Cuff elastic unwinder
- Leg cuff creating system (glue, thermosealing or ultrasonic)
- Press/pulling unit

#### FOLDING AND FINAL CUTTING AREA

- Progressive belt press
- Rotary die
- Longitudinal folder
- Final cutting unit
- Reject system
- Bi-folding/tri-folding unit
- Hot-melt system
- Manuals, drawings and software

- Full servo-motion system
- Hot melt system
- Manuals, drawings and software

#### OPTIONAL EQUIPMENT

- Second drum former with pad repitch and placer
- Backsheet with inline lamination
- Frontal tape unwinder
- Back and front panel construction and application module
- Rotary filter with second stage

- Additional size change kits
- Horizontal stacker
- Manual exit for stacker
- Single packing system
- Packaging machine
- Cartoning machine
- Soundproof cabin
- Quality system LS with line scan camera
- Wetness indicator
- Metal detector
- Lotion application system
- Sanyprint kit for flexographic printing on backsheet
- Glue vision system
- Material handling units

# Light inco converting machines

**Fitting in with market needs:** As a result of its unique experience in the adult care industry, ANDRITZ Diatec offers turn-key and comprehensive solutions for light inco producers. Each D-TECH light inco machine platform can be customized, according to customer requirements. Our flexibility in providing the best possible solution makes us the ideal partner for producers all around the world.



D-TECH light inco

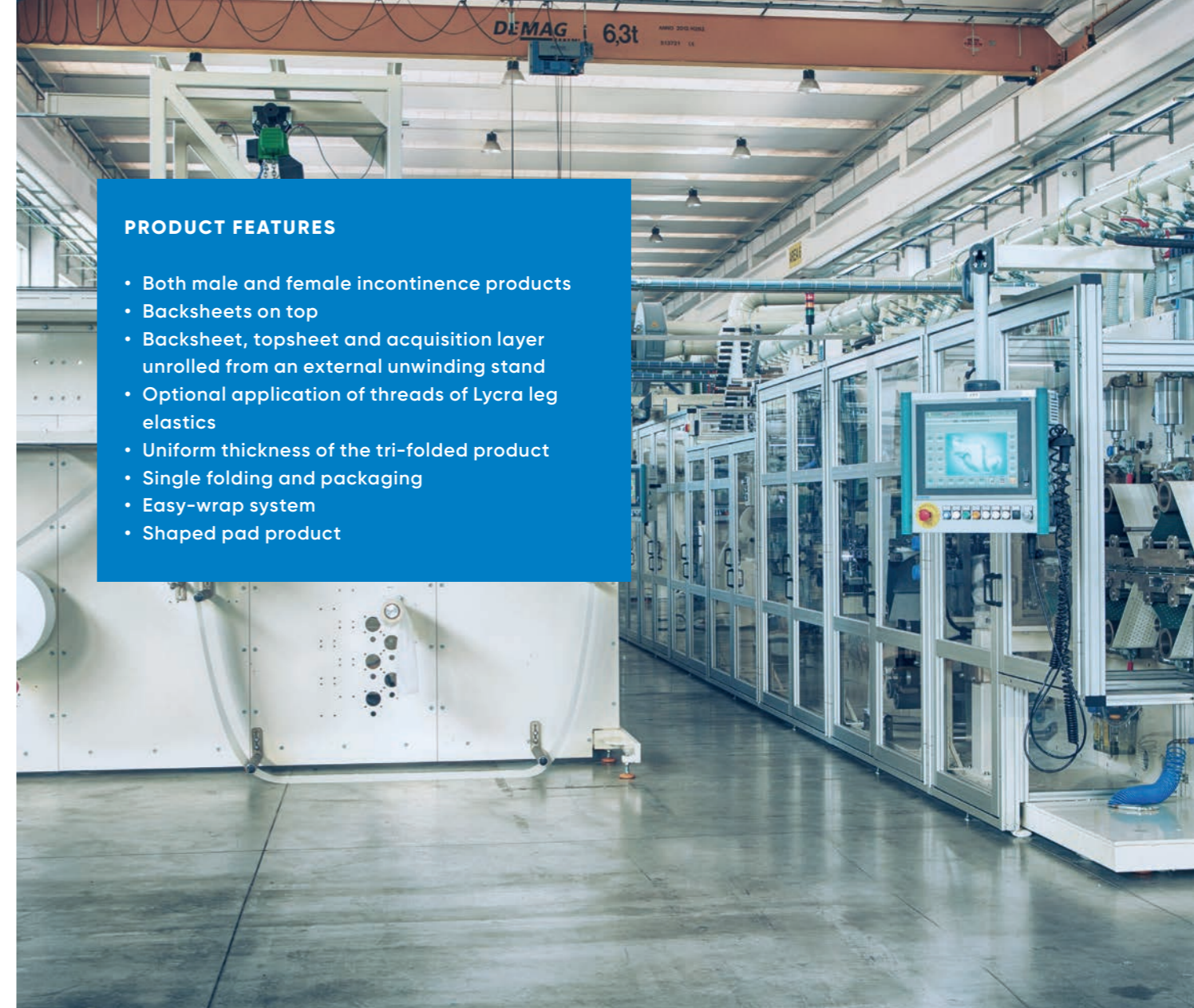
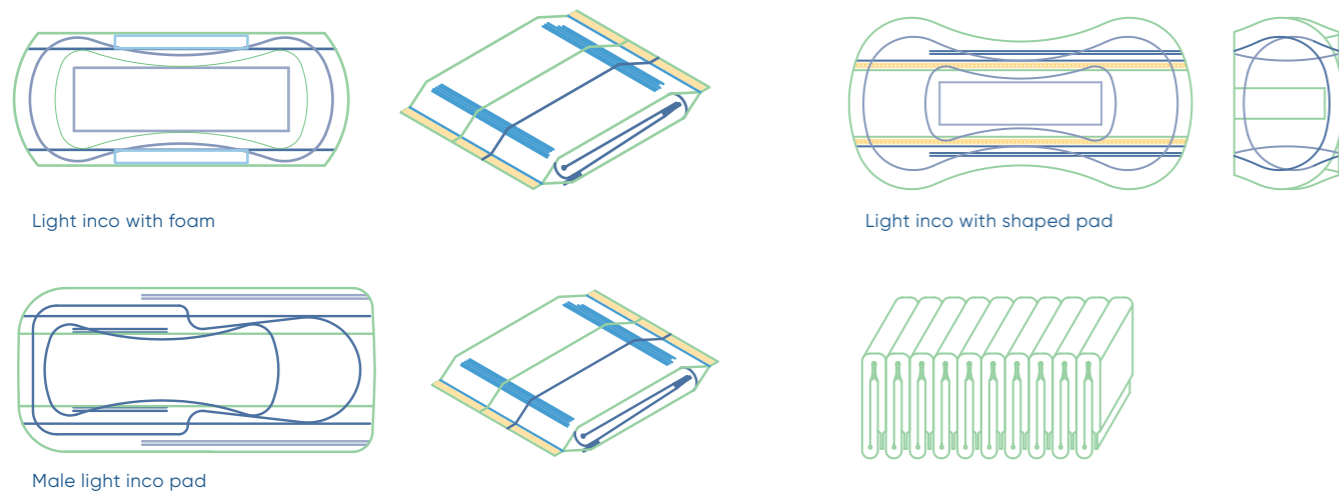

## PRODUCT FEATURES

- Both male and female incontinence products
- Backsheets on top
- Backsheet, topsheet and acquisition layer unrolled from an external unwinding stand
- Optional application of threads of Lycra leg elastics
- Uniform thickness of the tri-folded product
- Single folding and packaging
- Easy-wrap system
- Shaped pad product

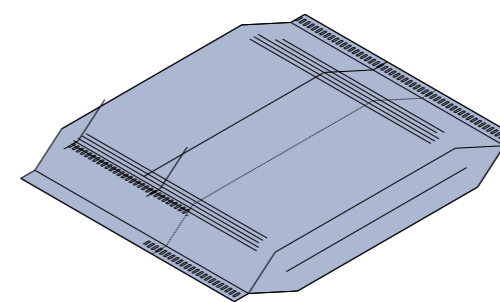

Pouch-wrapped light inco

## PRODUCT COMPOSITION

1. Release paper
2. TXT backsheet
3. Core
4. Foam
5. Acquisition layer
6. NW topsheet
7. PE bag

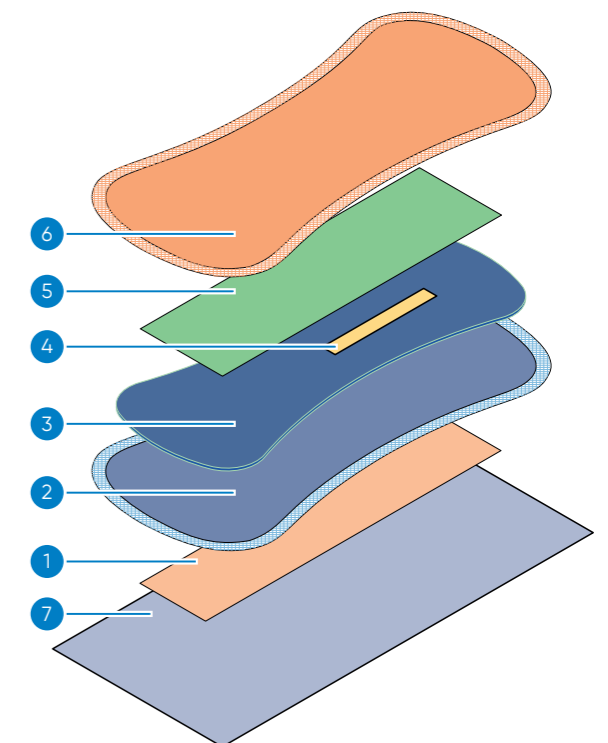



Flat step core processor

### MACHINE SPECIFICATIONS

Linear speed	Up to 400 m/min
Production speed	Up to 1,200 pcs/min
Uptime efficiency	85%
Waste	1-3%
Product dimensions	W: 100-220 mm L: 200-410 mm
Electric power supply	220/480 Vac, 50/60 Hz 3 phases + N + PE (24 Vdc auxiliary)
Consumed/installed electric power	220-400 kW
Compressed air supply/consumption	6 bar/2,000 NI/min
Overall dimensions (LxWxH)	25,600 x 9,600 x 4,500 mm
Total weight	85-95 tons
Required crew	2 persons (1 operator + 1 auxiliary)
Safety standard	CE



Drum former

### YOUR BENEFITS

- Flexibility in product composition
- Fully customized configuration
- Flexibility in core composition and S.A.P. concentration
- Ergonomic and operator-friendly process
- Fast size change

In light inco machines, components can be easily combined and configured for the specific product required.

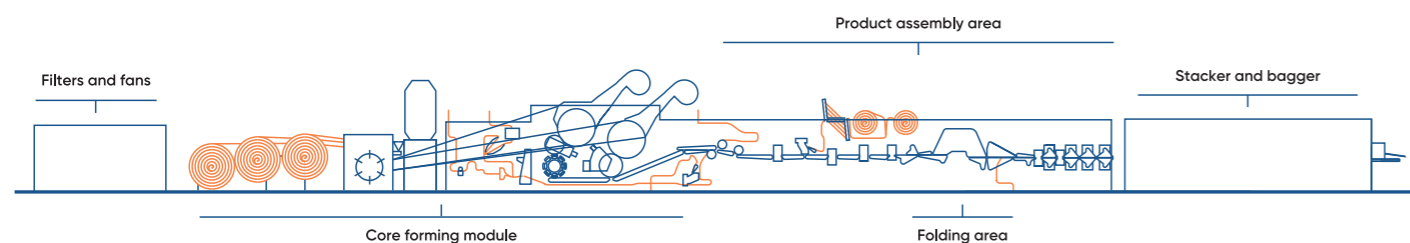

### CORE FORMING MODULE

- Cellulose pulp stand
- Compact disc mill (or hammer mill) with double inlet
- Drum former, 3D or flat
- Core processor
- Take-away drum
- S.A.P. dosing system

### PRODUCTS ASSEMBLY AREA

- Backsheet unwinder
- Topsheet unwinder
- Acquisition layer unwinder
- Leg elastic unwinder
- Embossing unit
- Contour sealing unit

### FOLDING AND FINAL CUTTING AREA

- Progressive conveyor press
- Contouring rotary die
- Trim suction system

- Reject system
- Bi-folding/tri-folding unit
- Poly bag unwinder
- Folding system for poly bag
- Bags sealing unit
- Bags separation conveyors

- Hot-melt system
- Manuals, drawing and software
- Onboard control panel

### OPTIONAL EQUIPMENT

- Second drum former with pad repitch and placer
- Phase control on backsheet
- Phase control on poly bag
- Soft-edge topsheet construction and application module
- High loft thermosealing or ultrasonic unit
- Silicon paper unwinder with cut

- and place applicator
- Easy-wrap module with rotation and repitch systems
- Closure tape applicator for bag
- Rotary filter with second stage
- Additional size change kits
- Horizontal stacker
- Manual exit for stacker
- Packaging machine
- Cartoning machine
- Soundproof cabin
- Quality system LS with line scan camera
- Glue vision system
- Wetness indicator
- Metal detector
- Lotion application system
- Sanyprint kit for flexographic printing
- Material handling units
- Intermittent foam applicator



AGL applicator



Intermittent foam applicator



Core processor

# Underpad converting machines

**Take advantage of a global supplier:** The leading supplier of converting machines for hygiene products enables you to benefit from the latest innovations in the adult hygiene market. Relying on its vast expertise, ANDRITZ Diatec can deliver the best technologies that suit the market's needs. With its D-TECH underpads machines, ANDRITZ Diatec offers custom platforms capable of working with a wide range of core fluff densities.

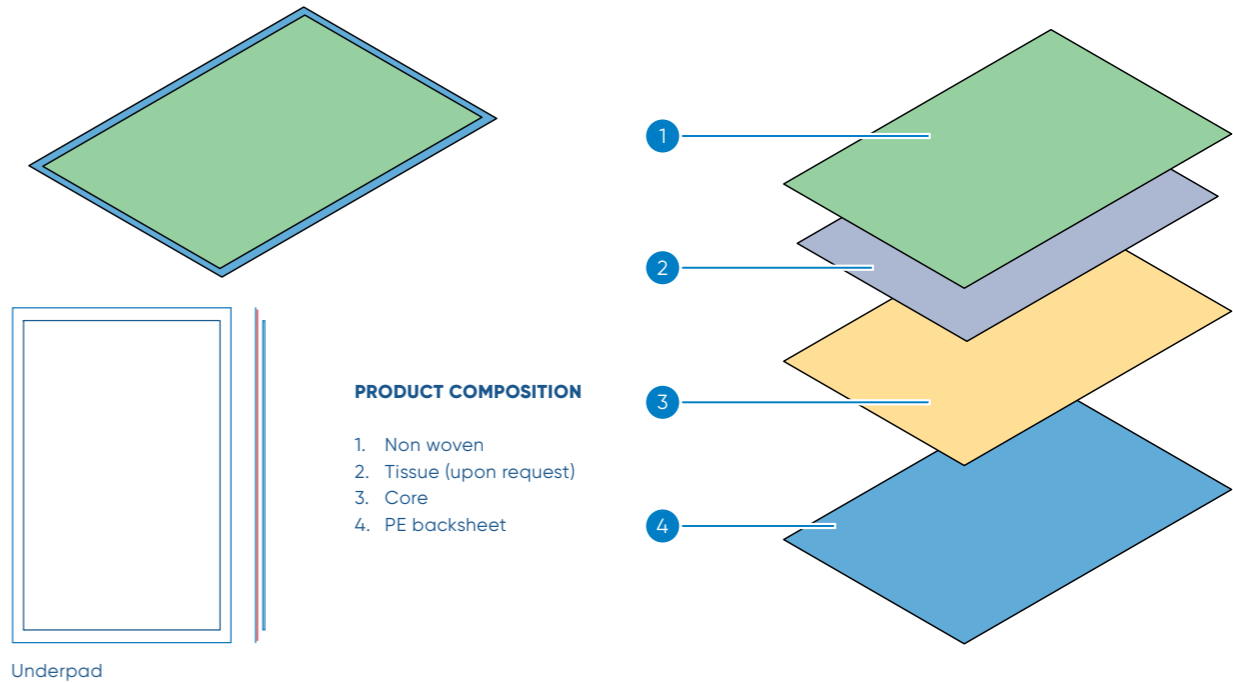

D-TECH underpad



## PRODUCT FEATURES

- Different and customizable sizes (40 x 60, 60 x 60, 60 x 90, 80 x 180 bed mats, but other sizes can be produced on request)
- Extreme consistency and integrity of the rectangular pad with low densities in the core
- Homogeneous thickness of the final product
- Flexible core composition: cellulose with or without tissue or airlaid

Pressing unit



D-TECH underpad

### MACHINE SPECIFICATIONS

Linear speed	Up to 350 m/min
Production speed	Up to 500 pcs/min
Uptime efficiency	85%
Waste	1-3%
Product dimensions	W: 400-600 mm L: 400-920 mm
Electric power supply	220/480 Vac, 50/60 Hz 3 phases + N + PE (24 Vdc auxiliary)
Consumed/installed electric power	350-550 kW
Compressed air supply/consumption	6 bar/2,000 NI/min
Overall dimensions (LxWxH)	23,500 x 8,200 x 6,200 mm
Total weight	70-80 tons
Required crew	2 persons (1 operator + 1 auxiliary)
Safety standard	CE

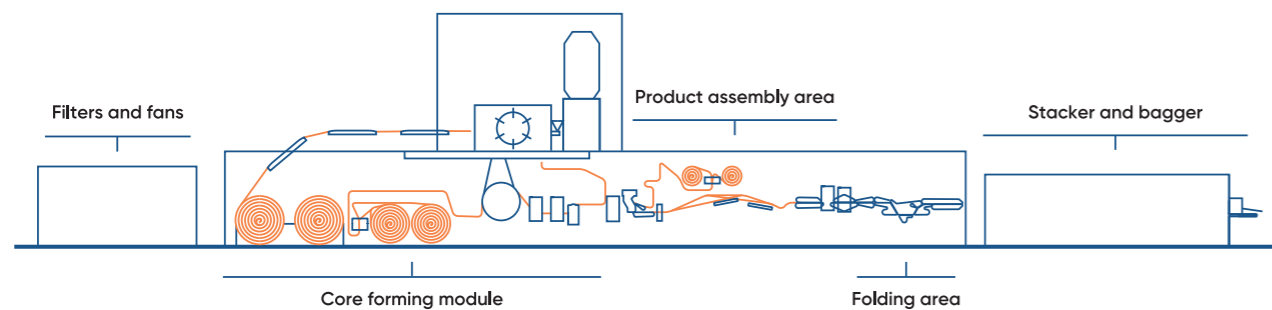

Mezzanine



### YOUR BENEFITS

- State-of-the-art technology
- Customization in core composition and fluff density
- Upgrades for quality and capacity increase
- Process stability and reliability
- Modular and compact design, small footprint, easy access for maintenance

Soundproof mezzanine

In underpad machines, components can be easily combined and configured for the specific product required.

### CORE FORMING MODULE

- Cellulose pulp stand
- Compact disc mill (or hammer mill) with double inlet
- Drum former
- Take-away drum

### OPTIONAL EQUIPMENT

- Core processor
- Embossing unit
- S.A.P. application
- Backsheet with inline lamination and registering control
- Rotary filter with second stage
- Additional size change kits
- Horizontal stacker
- Manual exit for stacker
- Packaging machine
- Cartoning machine
- Soundproof cabin
- Quality system LS with line scan camera
- Metal detector
- Glue vision system
- Material handling units
- Glue vision system
- Material handling units

### PRODUCT ASSEMBLY AND FINAL CUTTING AREA

- Backsheet unwinder
- Topsheet unwinder
- Longitudinal folder
- Final cutting unit
- Reject system
- Bi-folding/tri-folding unit
- Progressive belt press
- Full servo-motion system
- Hot-melt system
- Manuals, drawings and software





## GET THE MOST OUT OF YOUR INVESTMENT

At ANDRITZ Nonwoven, we know that your business depends on satisfied customers and efficient processes. That's why we support you in every aspect of your nonwoven production. Take advantage of technology that lets you produce consistent quality for decades to come. Profit from the highly efficient use of energy and raw materials that our production provides. You can rely on our responsive service teams, who will protect your investment and optimize your processes. Experience how innovative approaches and digital services give you more control than ever before. With ANDRITZ, the leading supplier for the nonwovens market, you get the most out of your investment.

### ITALY

ANDRITZ Diatec S.r.l.  
Collecervino, Italy  
p: +39 085 82060-1  
diatec@andritz.com

### GERMANY

ANDRITZ Küsters GmbH  
Krefeld, Germany  
p: +49 2151 34 0  
kuesters@andritz.com

### USA

ANDRITZ Inc.  
Spartanburg, USA  
p: +1 864 587 4848  
nonwoven-americas@andritz.com

### FRANCE

ANDRITZ Asselin-Thibeau SAS  
Elbeuf, France  
p: +33 2 32 96 42 42  
asselin-thibeau@andritz.com

### CHINA

ANDRITZ (China) Ltd.  
Wuxi branch office  
Wuxi, P.R. China  
p: +86 510 8536 1269  
nonwoven-china@andritz.com

ANDRITZ Perfojet SAS  
Montbonnot, France  
p: +33 4 76 52 23 11  
perfojet@andritz.com

### INDIA

ANDRITZ Technologies Pvt. Ltd.  
Chennai, India  
p: +91 44 4293 9393  
nonwovenservice.india@andritz.com

**ANDRITZ.COM/CONVERTING-NONWOVENS**

# ANDRITZ

All data, information, statements, photographs, and graphic illustrations in this leaflet are without any obligation and raise no liabilities to or form part of any sales contracts of ANDRITZ AG or any affiliates for equipment and/or systems referred to herein. © ANDRITZ GROUP 2020. All rights reserved. No part of this copyrighted work may be reproduced, modified or distributed in any form or by any means, or stored in any database or retrieval system, without the prior written permission of ANDRITZ AG or its affiliates. Any such unauthorized use for any purpose is a violation of the relevant copyright laws. ANDRITZ AG, Stattegger Strasse 18, 8045 Graz, Austria.  
KNW.ac.01.eng.10.20

